

**ONKYO**

# T-450RDS

## Quartz Synthesized FM Stereo/AM Tuner

### Instruction Manual

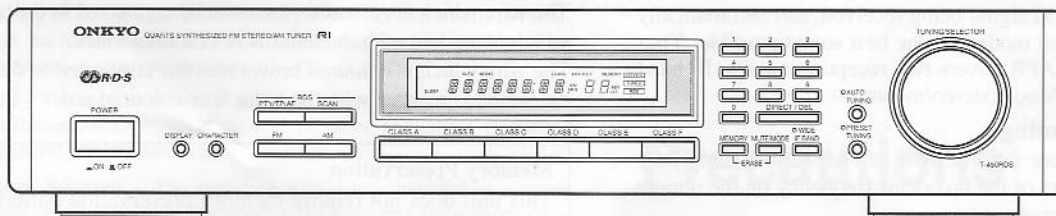

### CONTENTS

Features .....	1	Receiving stations .....	7
Important safeguards .....	2	Using preset stations .....	9
Precautions .....	2	Using preset stations .....	10
Control positions and names .....	3	Entering station names .....	11
Setting the voltage selector and tuning step frequency (Worldwide models only) .....	4	Receiving RDS (European models only).....	12
Making system connections .....	4	Receiving RDS (U.S.A models only).....	14
Making antenna connections .....	5	Trouble shooting guide .....	17
Connecting the power .....	6	Specifications .....	17

1. **Read Instructions** – All the safety and operating instructions should be read before the appliance is operated.
2. **Retain Instructions** – The safety and operating instructions should be retained for future reference.
3. **Heed Warnings** – All warnings on the appliance and in the operating instructions should be adhered to.
4. **Follow Instructions** – All operating and use instructions should be followed.
5. **Water and Moisture** – The appliance should not be used near water – for example, near a bathtub, washbowl, kitchen sink, laundry tub, in a wet basement, or near a swimming pool, and the like.
6. **Carts and Stands** – The appliance should be used only with a cart or stand that is recommended by the manufacturer.

6A. An appliance and cart combination should be moved with care. Quick stops, excessive force, and uneven surfaces may cause the appliance and cart combination to overturn.



7. **Wall or Ceiling Mounting** – The appliance should be mounted to a wall or ceiling only as recommended by the manufacturer.
8. **Ventilation** – The appliance should be situated so that its location or position does not interfere with its proper ventilation. For example, the appliance should not be situated on a bed, sofa, rug, or similar surface that may block the ventilation openings; or, placed in a built-in installation, such as a bookcase or cabinet that may impede the flow of air through the ventilation openings.
9. **Heat** – The appliance should be situated away from heat sources such as radiators, heat registers, stoves, or other appliances (including amplifiers) that produce heat.
10. **Power Sources** – The appliance should be connected to a power supply only of the type described in the operating instructions or as marked on the appliance.
11. **Polarization** – If the appliance is provided with a polarized plug having one blade wider than the other, please read the following information: The polarization of the plug is a safety feature. The polarized plug will only fit the outlet one way. If the plug does not fit fully into the outlet, try reversing it. If there is still trouble inserting it, the user should seek the services of a qualified electrician. Under no circumstances should the user attempt to defeat the polarization of the plug.
12. **Power-Cord Protection** – Power-supply cords should be routed so that they are not likely to be walked on or pinched by items placed upon or against them, especially near plugs, convenience receptacles, and the point where they exit from the appliance.
13. **Cleaning** – The appliance should be cleaned only as recommended by the manufacturer.
14. **Power Lines** – An outdoor antenna should be located away from power lines.
15. **Nonuse Periods** – The power cord of the appliance should be unplugged from the outlet when left unused for a long period of time.
16. **Object and Liquid Entry** – Care should be taken so that objects do not fall and liquids are not spilled into the enclosure through openings.
17. **Damage Requiring Service** – The appliance should be serviced by qualified service personnel when:
  - A. The power-supply cord or the plug has been damaged; or
  - B. Objects have fallen, or liquid has been spilled into the appliance; or
  - C. The appliance has been exposed to rain; or
  - D. The appliance does not appear to operate normally or exhibits a marked change in performance; or
  - E. The appliance has been dropped, or the enclosure damaged.
18. **Servicing** – The user should not attempt to service the appliance beyond that described in the operating instructions. All other servicing should be referred to qualified service personnel.

provide some protection against voltage surges and built-up static charges. Article 810 of the National Electrical Code, ANSI/NFPA 70, provides information with regard to proper grounding of the mast and supporting structure, grounding of the lead-in wire to an antenna discharge unit, size of grounding conductors, location of the antenna-discharge unit, connection to grounding electrodes, and requirements for the grounding electrode. See Figure 73.1.

**FIGURE 73.1:**  
**EXAMPLE OF ANTENNA GROUNDING AS PER NATIONAL ELECTRICAL CODE**

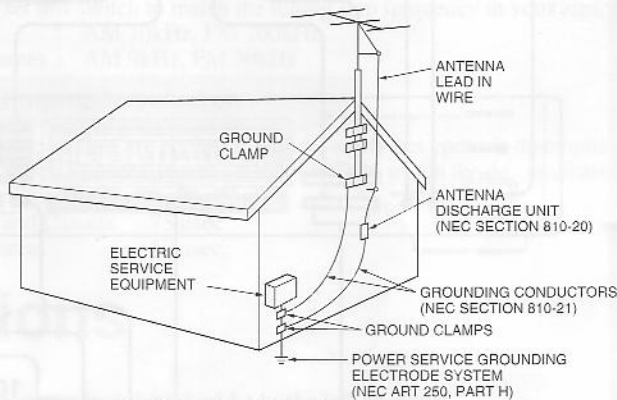

NEC – NATIONAL ELECTRICAL CODE

S2898A

## Precautions

### 1. Warranty Card

The serial number is written on the rear panel of this unit. Copy the serial number and model number onto your warranty card and keep it in a safe place.

### 2. Care

From time to time you should wipe the front and rear panels and the cabinet with a soft cloth. For heavier dirt, dampen a soft cloth in a weak solution of mild detergent and water, wring it out dry, and wipe off the dirt. Following this, dry immediately with a clean cloth. Do not use rough material, thinners, alcohol or other chemical solvents or cloths since these could damage the finish or remove the panel lettering.

### 3. Power

#### WARNING

BEFORE PLUGGING IN THE UNIT FOR THE FIRST TIME, READ THE FOLLOWING SECTION CAREFULLY.

- Some models are designed for use only with the power supply voltage of the region where they are sold.
 

European model (except U.K.):	AC 230V, 50Hz
U.K. and Australian models:	AC 240V, 50Hz
U.S.A. and Canadian models:	AC 120V, 60Hz
Worldwide model:	AC 120V/220V switchable, 50/60Hz

- **Voltage Selector (Rear Panel)**

Worldwide models are equipped with a voltage selector to conform with local power supplies. Be sure to set this switch to match the voltage of the power supply in your area before turning the power button on. (See "Setting the voltage selector and tuning step frequency (Worldwide models only)", P. 4.) Models without a voltage selector can only be used in areas where the power supply is the same as that of the unit.

# Control positions and names

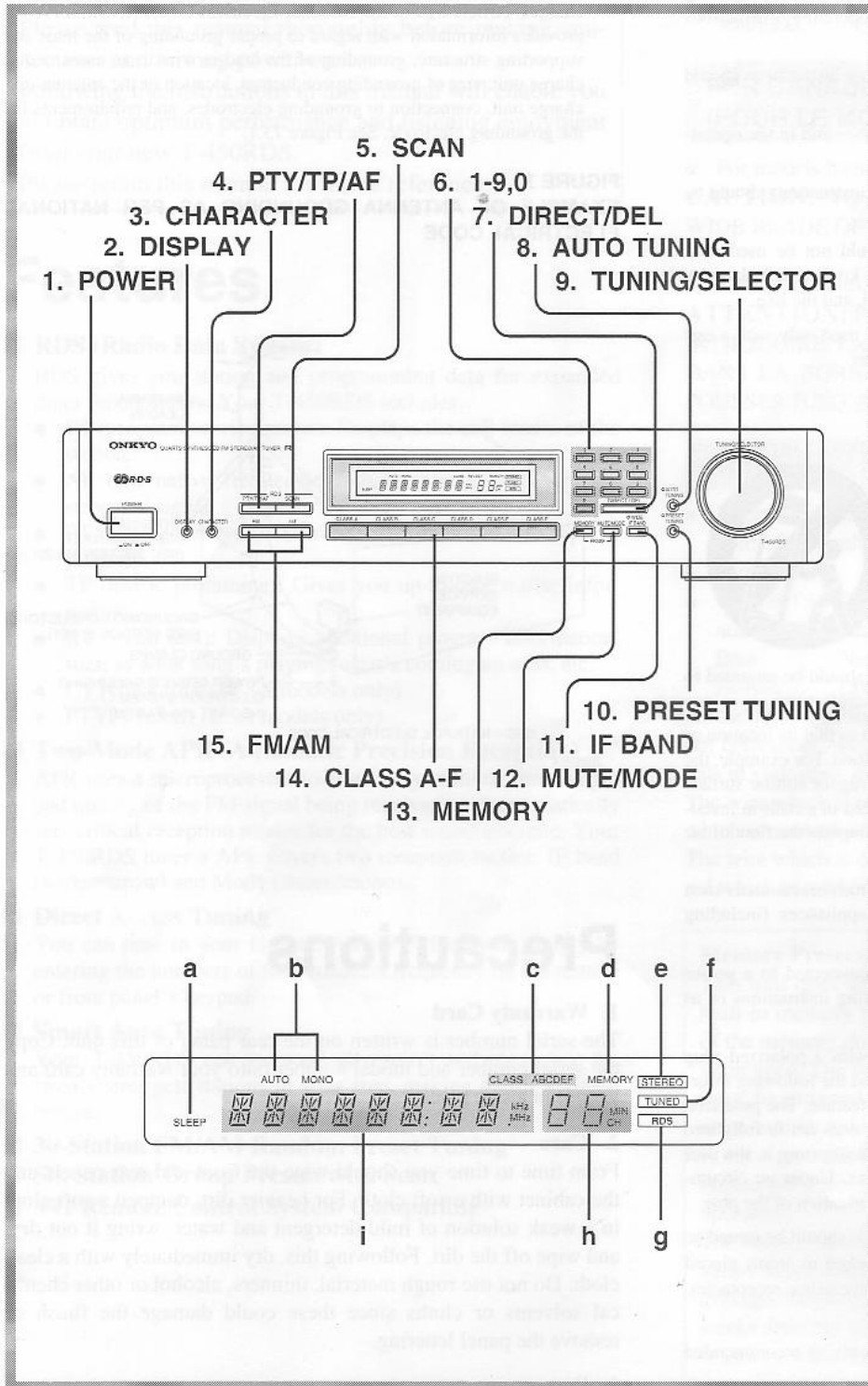

## NOTE:

If there is a protective film on the surface of the display, which is making it difficult to read the display, remove it.

For more information about buttons, turn to the page number in the brackets ([ ]).

### Front panel

1. Power button [6]
2. Display button [13, 15]
3. Character button [11]
4. RDS button [13, 15]
5. Scan button [13, 15]
6. Number buttons [8]
7. Direct/del button [8]
8. Auto tuning button and indicator [7]
9. Tuning/selector dial [7]
10. Preset tuning button and indicator [7, 10]
11. IF bandwidth selector button [8]
12. FM mute/mode button [8, 10]
13. Memory button [9, 11]
14. Classified memory buttons [9, 10]
15. Band selector buttons [7, 9]

### The Display

- a. Sleep indicator
- b. Stereo auto/mono indicator
- c. Preset station indicator
- d. Memory indicator
- e. Stereo indicator
- f. Tuned indicator
- g. RDS station received indicator
- h. Memory channel / Sleep time display
- i. Multi display

### SLEEP indicator

The T-450RDS does not have a sleep function.

However, if the T-450RDS is connected to an amplifier with the **RI** mark, and the SLEEP button on the remote control is pressed, the SLEEP indicator on the T-450RDS will light up. When the SLEEP button is pressed again, the indicator will turn off.

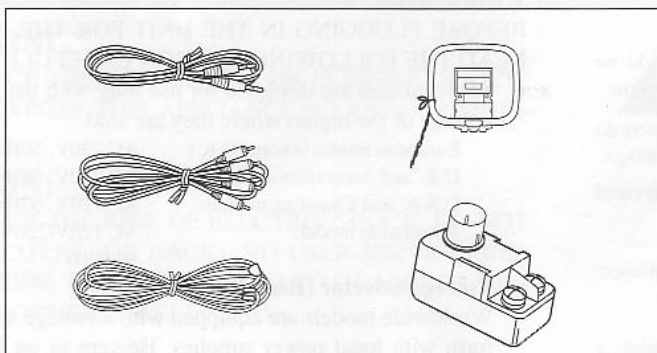

### Supplied accessories

- |                          |   |
|--------------------------|---|
| 1 Remote control cable   | 1 AM loop antenna                                 |
| 1 Audio connection cable | 1 75/300 ohm antenna adapter (U.S.A. & worldwide) |
| 1 T-shaped FM antenna    |   |

# frequency (Worldwide models only)

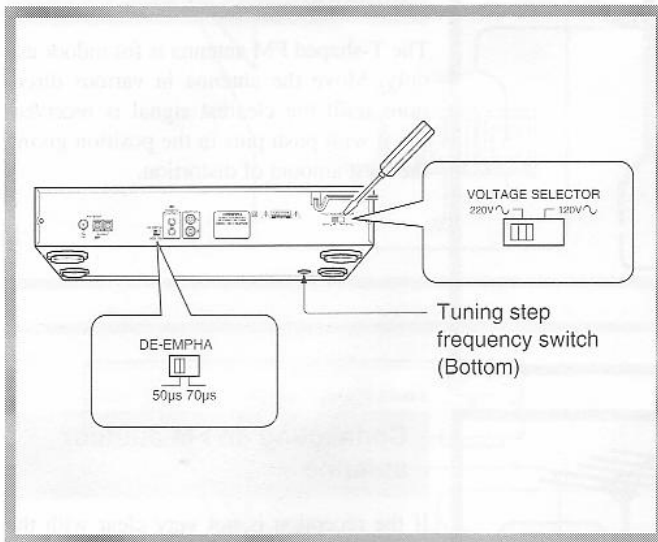

## Voltage selector

1. Determine the proper voltage for your area: 220V or 120V.
2. If the preset voltage is not correct for your area, insert a screwdriver into the groove in the switch. Slide the switch all the way to the right (120V) or to the left (220V), whichever is appropriate.

## Tuning step frequency

Worldwide models are equipped with a switch that controls the AM (9kHz/10kHz) and FM (50kHz/200kHz) bands tuning steps.

Please set this switch to match the tuning step frequency in your area.

U.S.A. : AM 10kHz, FM 200kHz

Other areas : AM 9kHz, FM 50kHz

## De-Emphasis selector

Worldwide models are equipped with a switch that controls de-emphasis (50 µsec - 75 µsec). Please set this switch to match the de - emphasis in your area.

U.S.A and Canada 75 µsec

Other areas 50 µsec

# Making system connections

- Do not plug in the power cord until all connections have been made.
- The lower jack (marked R) corresponds to the right channel, and the upper jack (marked L) to the left channel.

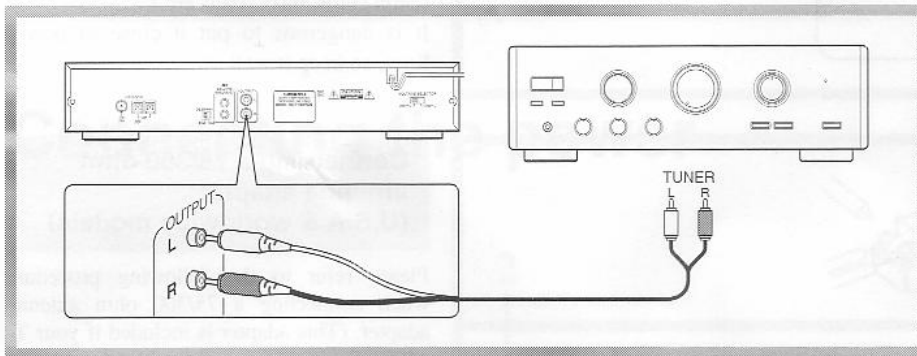

## Connecting the amplifier

Connect the tuner's OUTPUT jacks and the amplifier's INPUT jacks using the audio connection cable. Refer to the amplifier's instruction manual for connections.

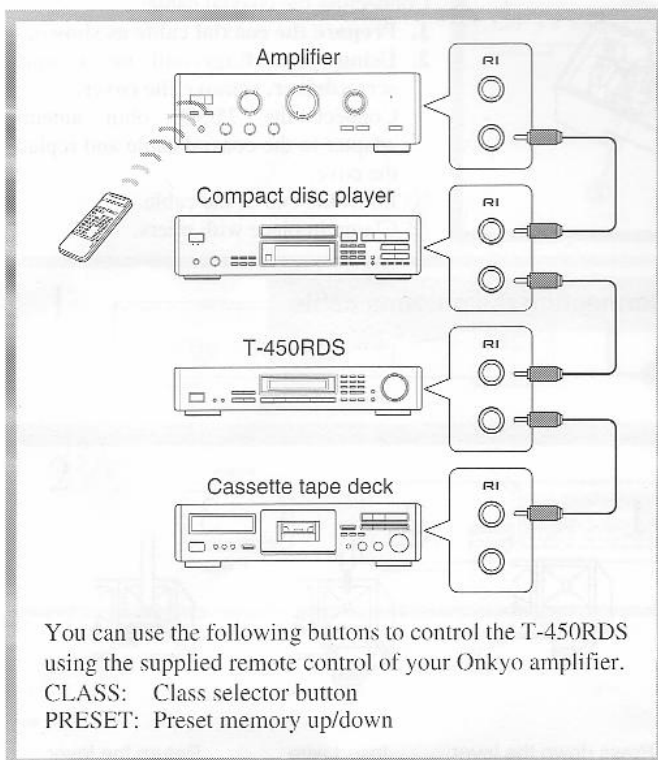

## Connecting Onkyo components for RI operation

When the T-450RDS is connected to an amplifier with the Onkyo **RI** mark, you are able to operate it by pressing the TUNER buttons on the amplifier's supplied remote control.

When connecting Onkyo products, it is necessary to attach the **RI** cable to be able to use the remote control of the amplifier to control the entire system.

1. To use this tuner with an amplifier, cassette tape deck and compact disc player with the **RI** mark, insert the remote control cable plugs into the REMOTE CONTROL jacks as shown.
2. As the exact connection sequence of the **RI** cable is unimportant, you can connect from the amplifier to either the tuner, the cassette tape deck or to the compact disc player.
3. To operate correctly, the remote control must face towards the remote control sensor of the amplifier.

### NOTE:

- The upper and lower **RI** remote control jacks have the same function.
- Remote control operation is not possible when only the remote control cable is connected — the audio connection cables must also be connected.
- An **RI** remote control cable equipped with a 1/8" (3.5mm) diameter miniature two-conductor phone plug is included with the T-450RDS and with every compact disc player and tuner with the **RI** mark.

# Making antenna connections

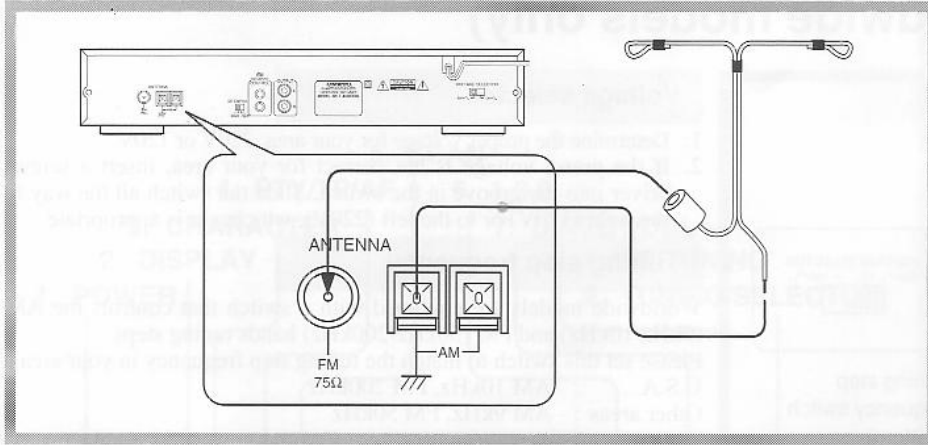

## Connecting the T-shaped FM antenna

The T-shaped FM antenna is for indoor use only. Move the antenna in various directions until the clearest signal is received. Fix it with push pins in the position giving the least amount of distortion.

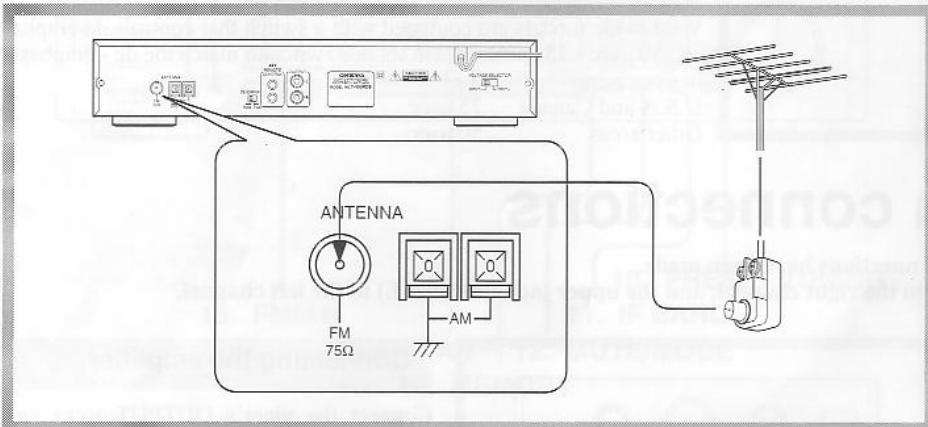

## Connecting an FM outdoor antenna

If the reception is not very clear with the attached T-shaped FM antenna, the use of an external antenna is recommended. Please make sure that you comply with the following considerations regarding the location. Keep the antenna away from noise sources (neon signs, busy roads etc.) It is dangerous to put it close to power lines, so keep it well away.

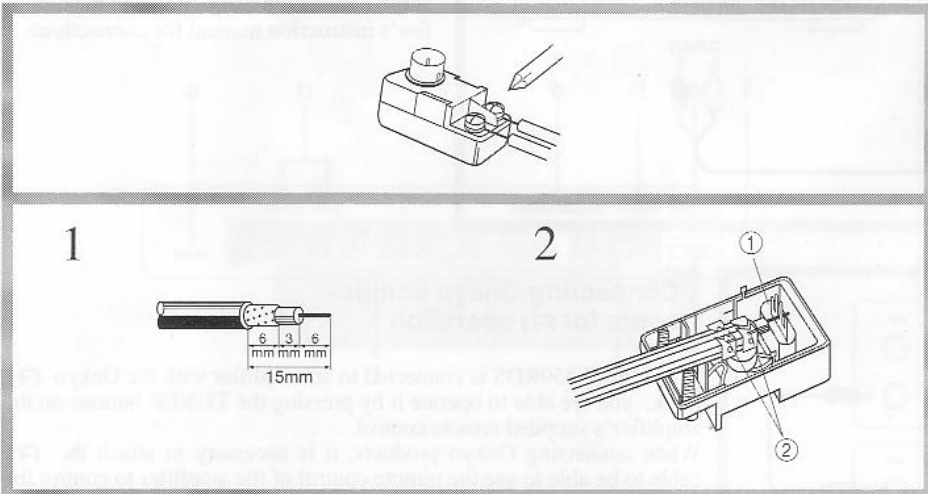

## Connecting a 75/300 ohm antenna adapter (U.S.A & worldwide models)

Please refer to the following procedure when connecting a 75/300 ohm antenna adapter. (This adapter is included if your T-450RDS is a U.S.A. or worldwide model.) Connecting the coaxial cable:

1. Prepare the coaxial cable as shown.
  2. Using your fingernail or a small screwdriver, remove the cover. Connect the 75/300 ohm antenna adapter to the coaxial cable and replace the cover.
- ① Insert the end of the cable.  
② Clamp in place with pliers.

## Assembling the AM loop antenna

Assemble the loop antenna as shown in the illustration.

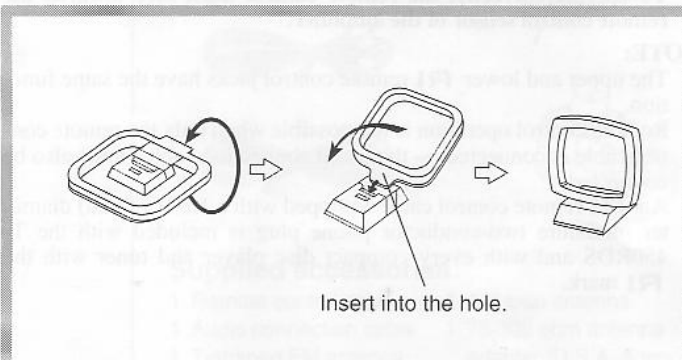

## Connecting the antenna cable

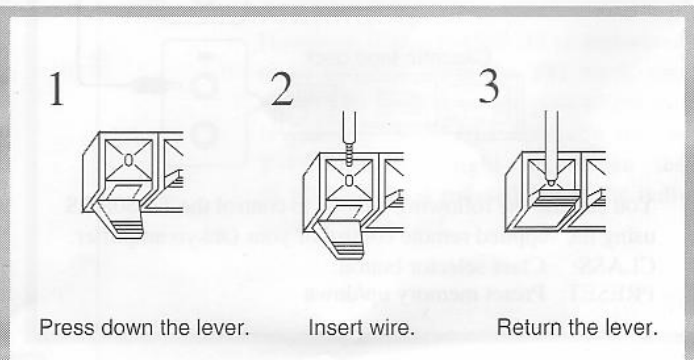

antenna

The AM loop antenna is for indoor use only. Set it to the direction where you can receive the clearest sound. Put it as far as possible away from the main unit, TV sets, speaker cords and power cords.

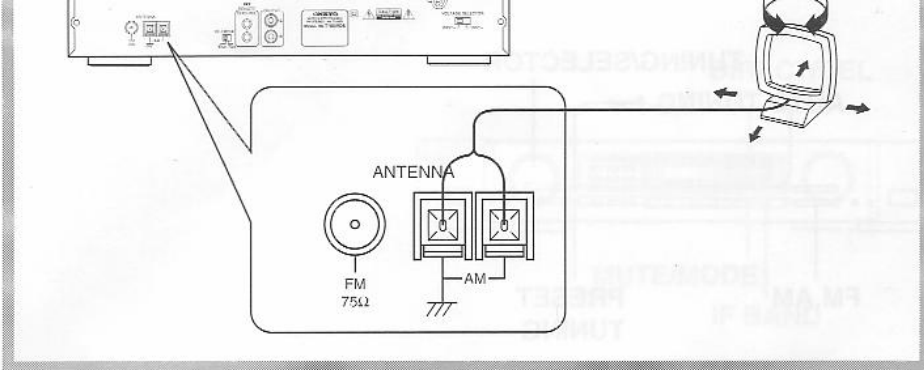

### Connecting the AM outdoor antenna

When reception is not satisfactory by the use of the attached AM loop antenna alone, connection of the external antenna is recommended. (Do not remove the AM loop antenna) The external antenna will be more effective if you stretch it horizontally in a high place above a window or outside.

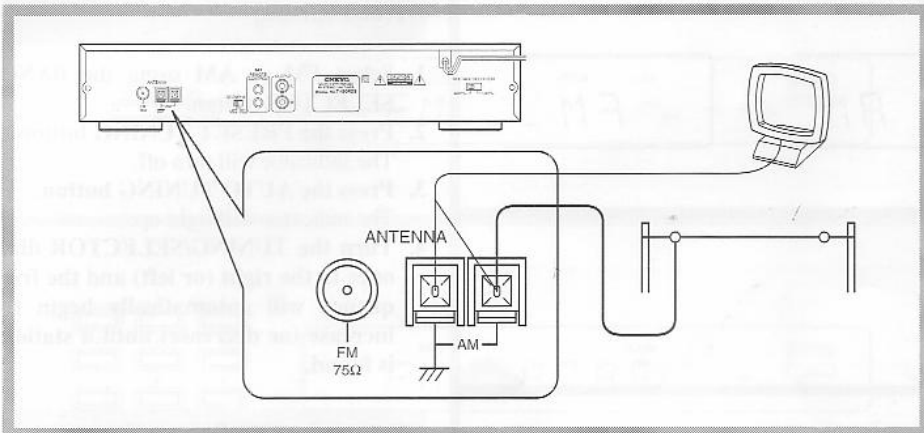

## Connecting the power

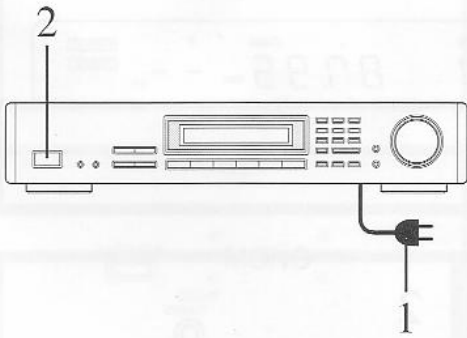

### Connecting the power

1. Insert the AC power supply cord into the wall outlet.
2. Press the POWER button. The display will light up.

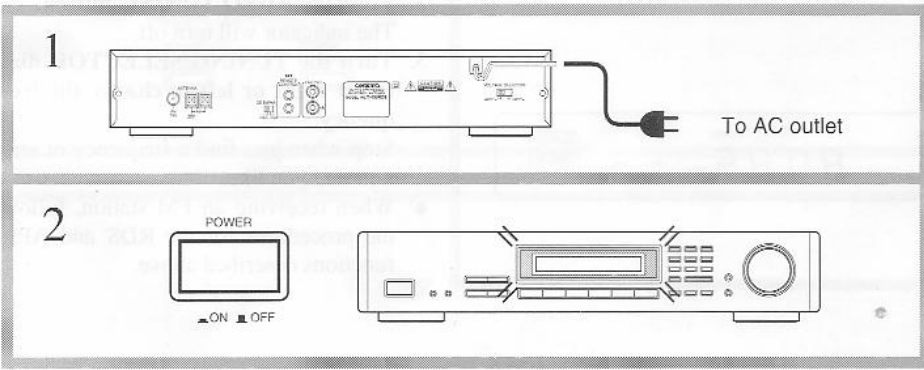

# Receiving stations

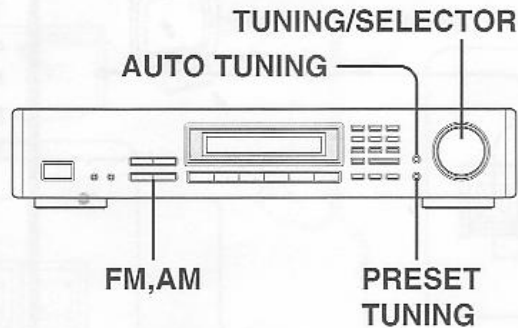

## Auto tuning

1. Select FM or AM using the BAND SELECTOR button.
2. Press the PRESET TUNING button. The indicator will turn off.
3. Press the AUTO TUNING button. The indicator will light up.
4. Turn the TUNING/SELECTOR dial once to the right (or left) and the frequency will automatically begin to increase (or decrease) until a station is found.

## Receiving an FM station

When a station is first received, the AUTO/MONO and IF BAND WIDE/NARROW settings are automatically set by the APR system. If you want to change the settings, you can use the MUTE/MODE button or the IF BAND button. (See "The MUTE/MODE button" and "The IF BAND function" on page 8.)

The PS (the name of the station) is shown on the display when in RDS mode (see RDS on page 12 and 14). If you wish to see the frequency display instead, press the DISPLAY button.

## Manual tuning

1. Press the PRESET TUNING button. The indicator will turn off.
  2. Press the AUTO TUNING button. The indicator will turn off.
  3. Turn the TUNING/SELECTOR dial to the right or left to change the frequency. Stop when you find a frequency or station that you like.
- When receiving an FM station, follow the procedures for the RDS and APR functions described above.

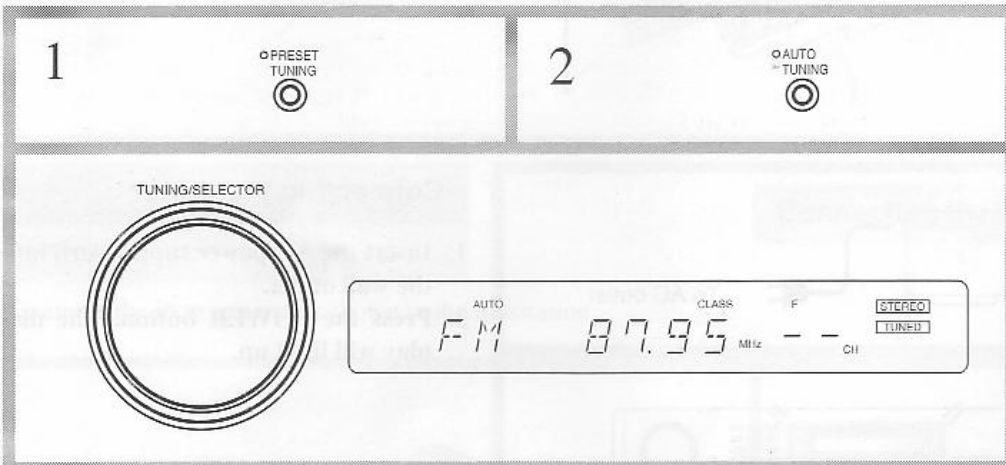
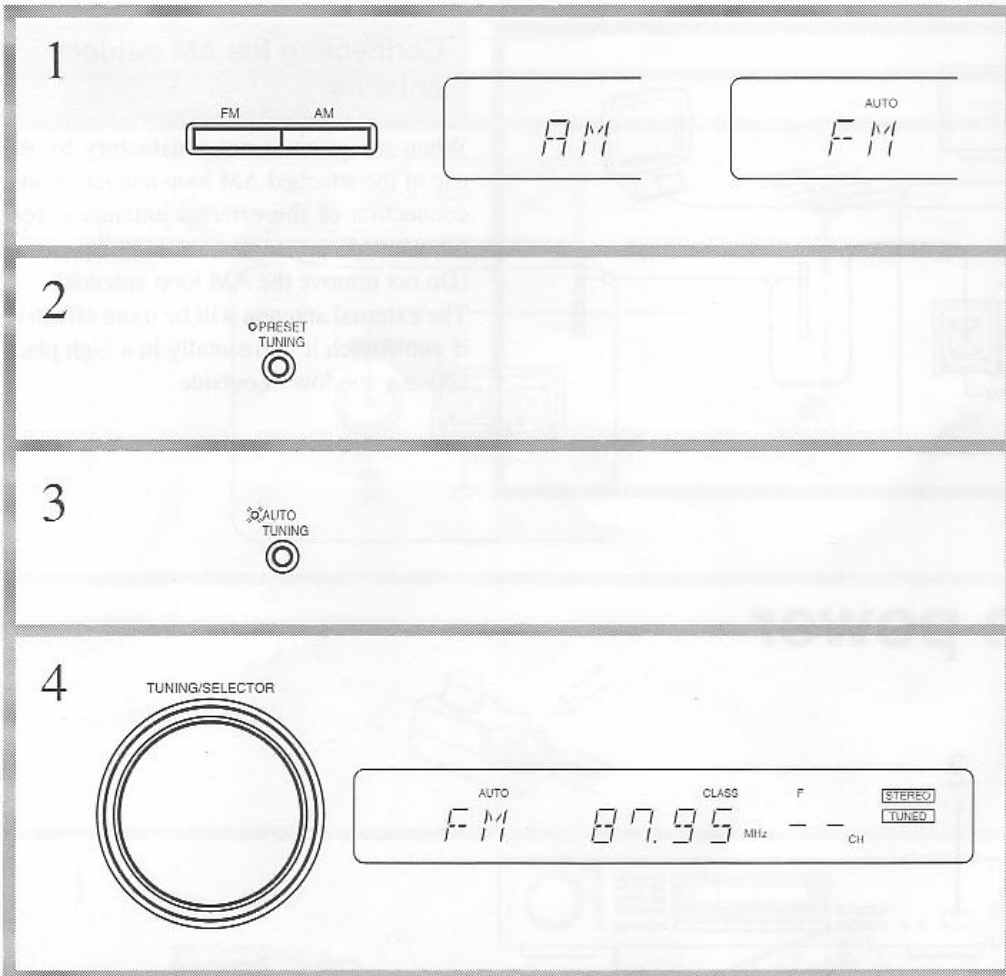

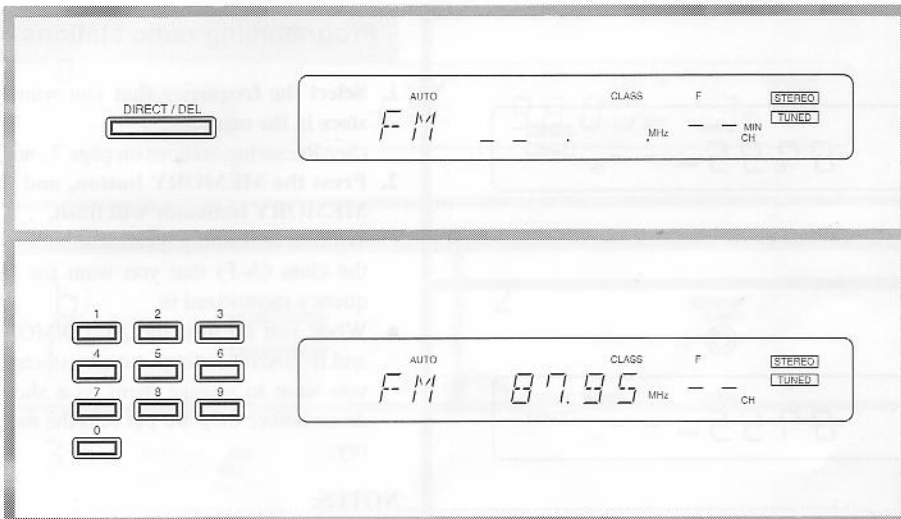
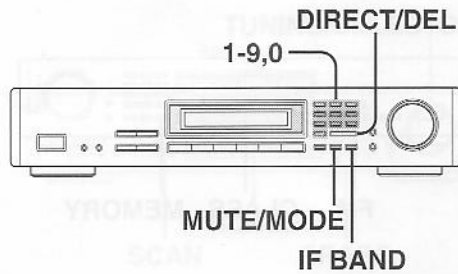

### Direct tuning

1. Press the **DIRECT/DEL** button.
2. Enter the frequency with the **number buttons** (the numbers will flash on the display).
  - If you enter a frequency that is out of range, the T-450RDS will return to the previous frequency. If this happens, repeat the procedure.
  - If you enter a frequency that does not have a station, the T-450RDS will automatically tune to the next station immediately below that frequency.
  - When receiving an FM station, follow the procedures for the RDS and APR functions previously described. Place the AM loop antenna or T-shaped FM antenna on a wall or other surface in the position which gives the best reception.



### The IF BAND function

If two FM stations have frequencies that are too close together, they may interfere with each other and be difficult to hear. If this happens, press the IF BAND button to turn the WIDE indicator off. The NARROW band will decrease the interference.

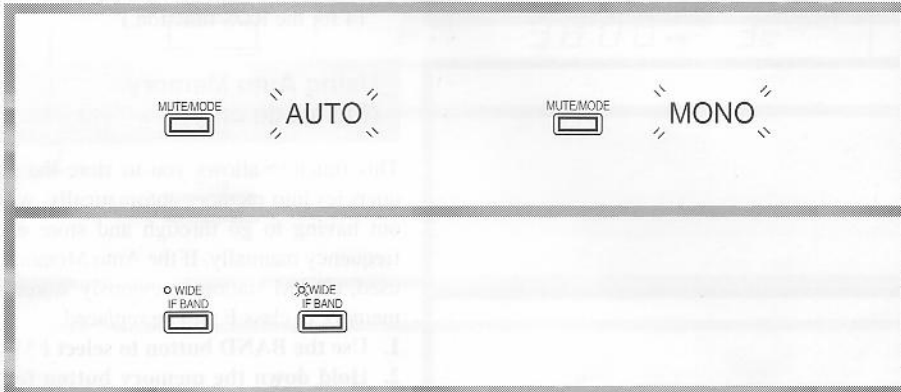

### The APR system

The T-450RDS is equipped with an APR system to help tune in FM stations. When receiving an FM station using auto, manual or direct tuning, AUTO/MONO and IF BAND WIDE/NARROW settings are made automatically, according to the station being received. If the MONO indicator lights up while a station is tuned in, the station will be received in mono even if it is a stereo station. The settings that the APR system makes can be changed by pressing the MUTE/MODE button or the IF BAND button.

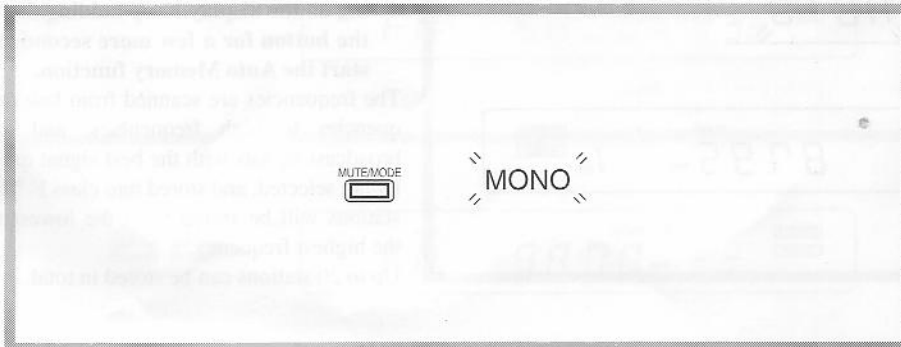

### Listening to a stereo radio station

- If you tune in a stereo FM station, the STEREO display will be illuminated if the signal is sufficiently strong. If the signal is weak, it may be impossible to tune into your desired station. In this case, tune in as follows.
1. Press the **MUTE/MODE** button and the **MONO** display lights.
  2. Select the station you would like to listen to using manual tuning mode.



# Using preset stations

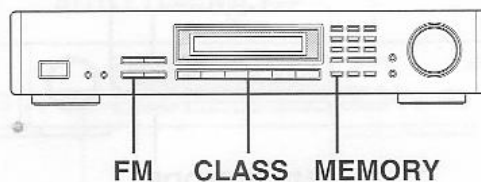

## Programming radio stations

1. Select the frequency that you want to store in the memory.  
(See Receiving Stations on page 7 and 8.)
2. Press the **MEMORY** button, and the **MEMORY** indicator will flash.  
While it is flashing, press the button of the class (A-F) that you want the frequency memorized in.
  - When you do this, the AUTO/MONO and IF BAND settings are also stored. If you want to change them, you should do so before they are put into the memory.

### NOTES:

- AM stations can be stored in the memory using the same procedure.
- Up to 30 FM and AM stations can be stored in the preset memory in total.
- If the FM station received is an RDS station with a PS (Program Service Name), the frequency display will change to the PS display.  
If there is no PS, the frequency display will not change. (Refer to page 12 and 14 for the RDS function.)

## Using Auto Memory (FM mode only)

This function allows you to store the frequencies into memory automatically, without having to go through and store each frequency manually. If the Auto Memory is used, all FM stations previously stored in memory in class F will be replaced.

1. Use the **BAND** button to select **FM**.
2. Hold down the memory button for a few seconds. "AUTO" will start flashing on the display. Keep holding down the button for a few more seconds to start the Auto Memory function.

The frequencies are scanned from low frequencies to high frequencies, and the broadcast signals with the best signal quality are selected, and stored into class F. The stations will be stored from the lowest to the highest frequency.

Up to 20 stations can be stored in total.

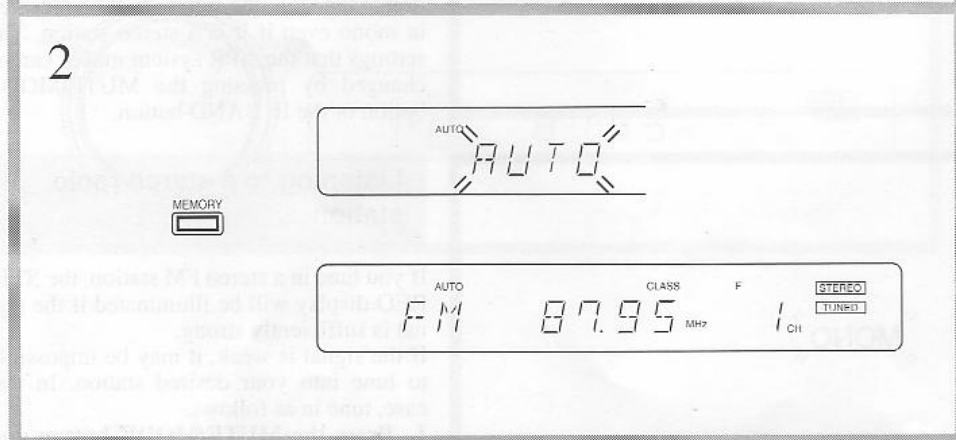
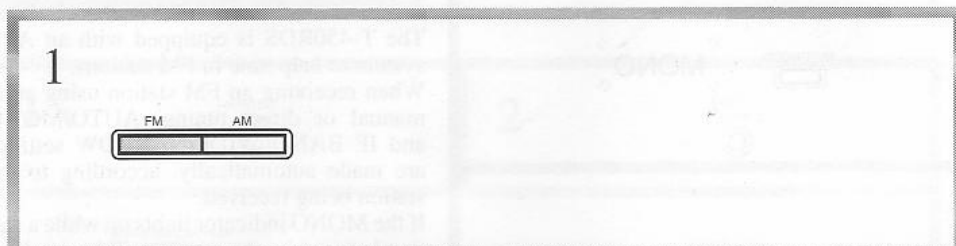
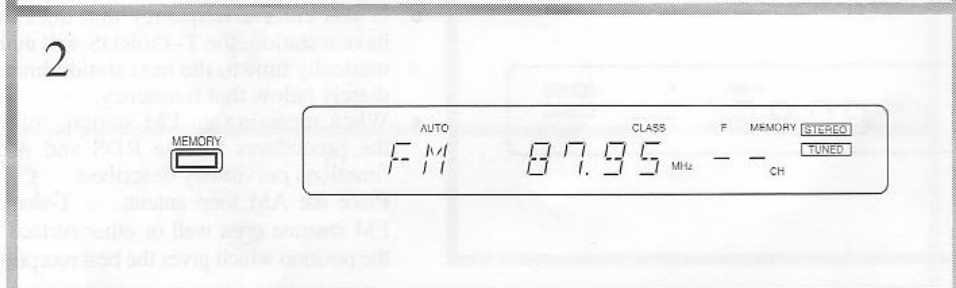
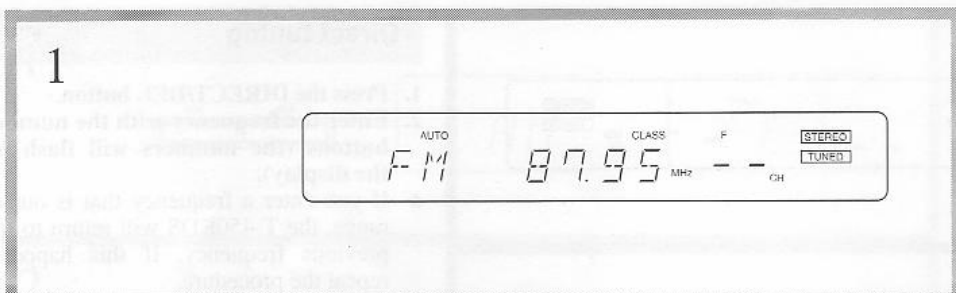

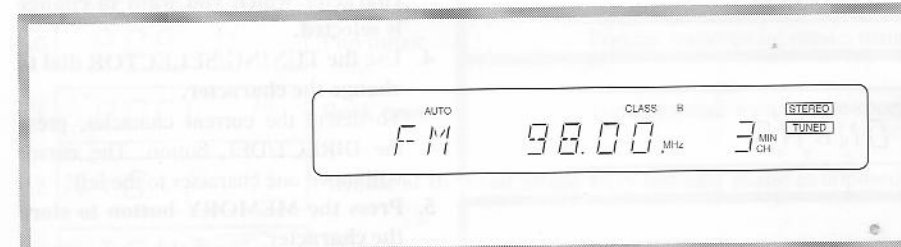
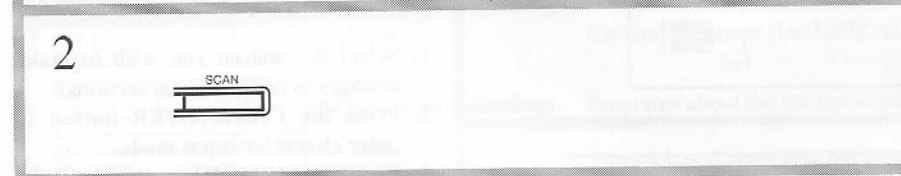
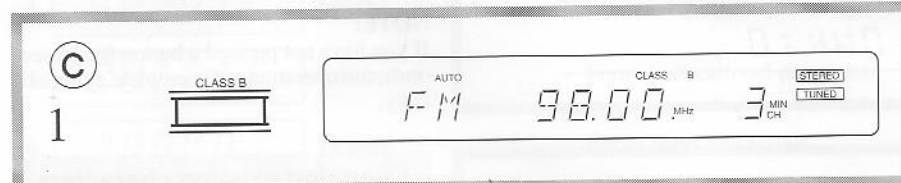
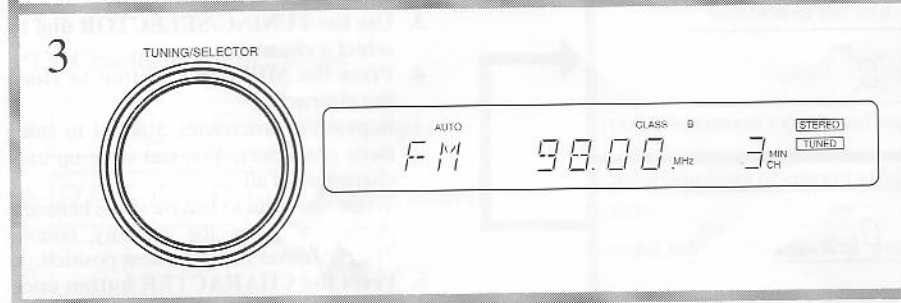
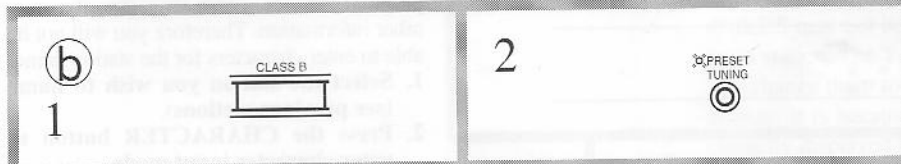
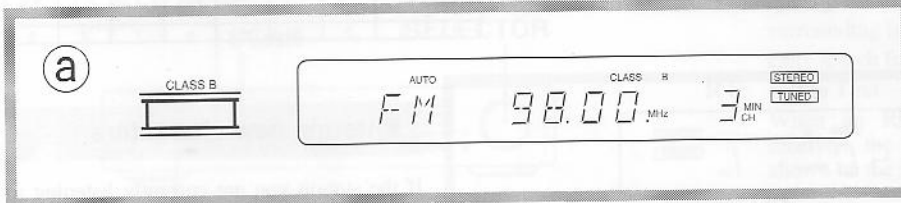
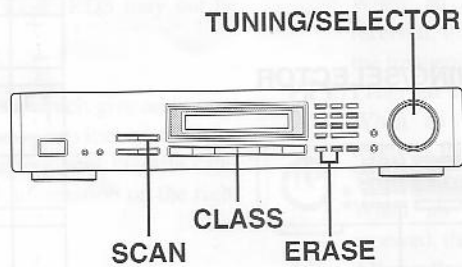

### Recalling preset stations

**(a)** Press the button of the class (A-F) that the desired station is in.

Each time the button is pressed, the preset stations in that class will be stepped through.

**(b)** 1. Press the button of the class (A-F) that the desired station is in.

2. Press the PRESET TUNING button, and the indicator will light up.

3. Turn the TUNING/SELECTOR dial, and the preset stations in that class will be recalled one at a time.

- If you want to change the stored AUTO/MONO or IF BAND settings of a preset station, press the MUTE/MODE or IF BAND buttons while the preset station is selected. The memory indicator will then start to flash, so press the MEMORY button to confirm the changes.

Note: This does not work in the PTY, TP or AF modes.

**(c)** 1. Press the button of the class (A-F) that the desired station is in.

2. Press the SCAN button.

Each of the preset stations within the selected class will be tuned in for 5 seconds, in turn.

When the desired station is reached, or you want to stop scanning, press the SCAN button a second time.

The Tuner will automatically switch to AM or FM according to the station selected.

### Cancelling preset stations

1. Select the preset station as explained in the previous section.

2. Press and hold the MEMORY button and within a second of doing this, press the MUTE/MODE button.

"--" will be shown on the MEMORY channel display.

3. Once the preset station has been cancelled, the memory location can be used to store another station.

Note that if you fail to press the AUTO/MONO button while holding down the MEMORY button, the AUTO MEMORY will start.

# Entering station names

The following 54 characters can be used.

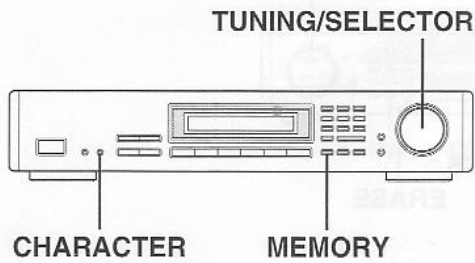

	A	B	C	D	E	F	G	H
I	J	K	L	M	N	O	P	Q
R	S	T	U	V	W	X	Y	Z
"	~	'	\	*	+	,	--	
"	&	'	(	)	*	+	,	.
\	/	=	P	C	\	3	1	0
.	/	=	?		\			0
1	2	3	4	5	6	7	8	9
1	2	3	4	5	6	7	8	9

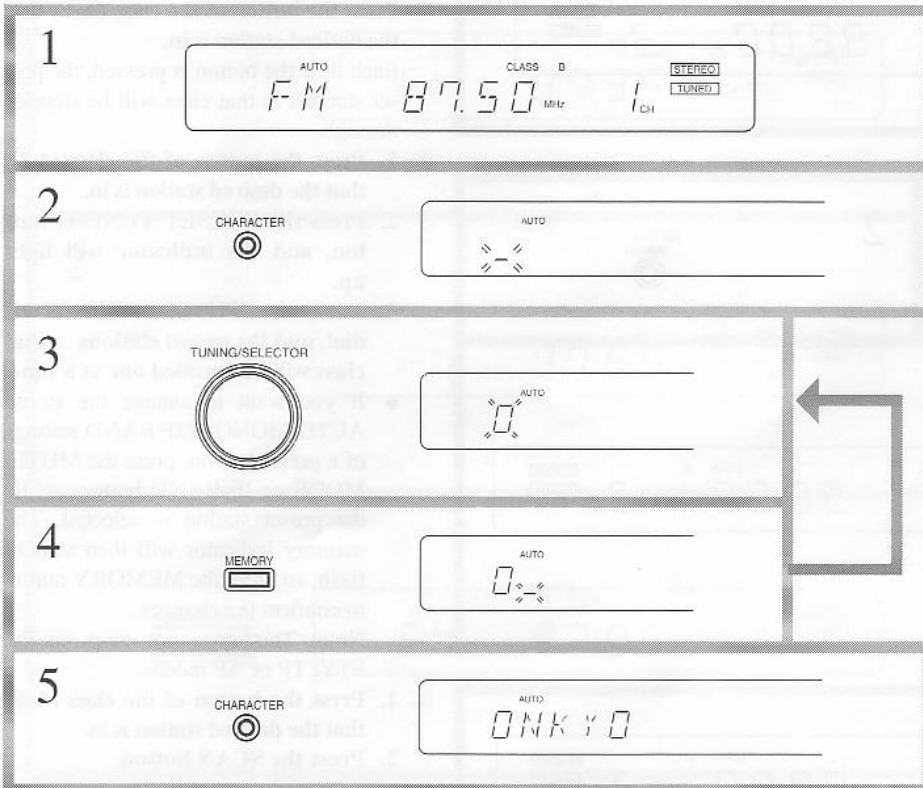

## Entering new characters

If the station you are currently listening to on the T-450RDS is an RDS station, the program service name has priority over other information. Therefore you will not be able to enter characters for the station name.

1. Select the station you wish to name (see previous sections).
2. Press the CHARACTER button to enter character input mode.
3. Use the TUNING/SELECTOR dial to select a character.
4. Press the MEMORY button to store the character.

Repeat the procedures 3 and 4 to store more characters. You can store up to 8 characters in all.

When you want to leave a space between characters, press the memory button. The bar moves on to the next position.

5. Press the CHARACTER button once again to complete the operation.

### NOTE:

If you have not pressed a button for 16 seconds, the operation will complete automatically.

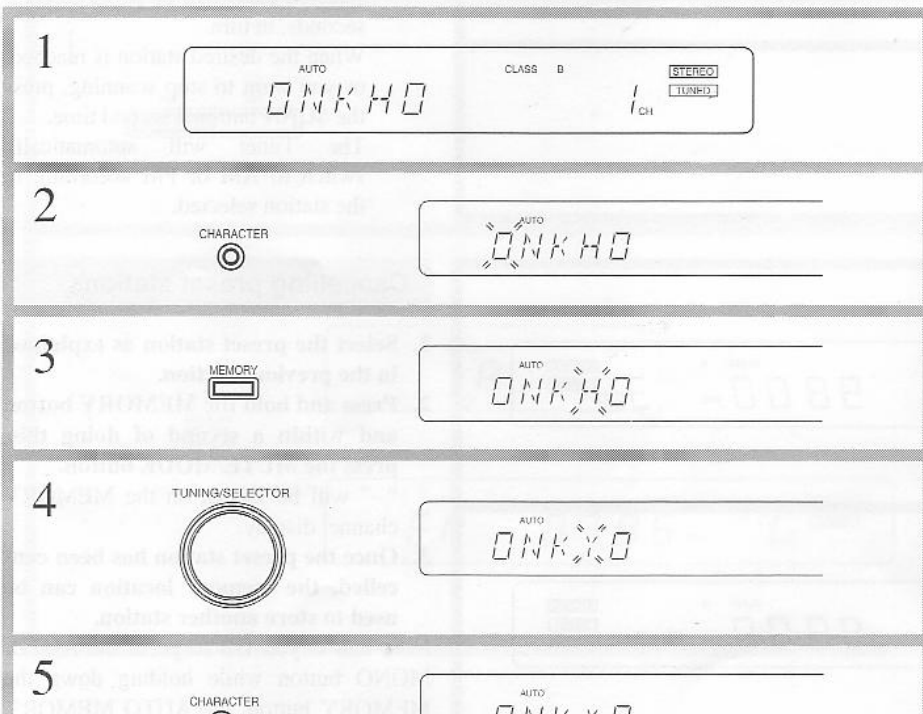

## Changing existing characters

1. Select the station you wish to make changes to (see previous sections).
2. Press the CHARACTER button to enter character input mode.
3. Press the MEMORY button until the character which you want to change is selected.
4. Use the TUNING/SELECTOR dial to change the character.  
To delete the current character, press the DIRECT/DEL button. The cursor will move one character to the left.
5. Press the MEMORY button to store the character.

## Clearing all of the characters stored in memory

1. Press the CHARACTER button.
2. Hold down the MEMORY button then press the MUTE/MODE button.

RDS reception is only available in areas where RDS broadcasts are available. However, if radio reception is weak, RDS may not be received.

### What is RDS?

Many FM stations now transmit RDS signals which give additional information. RDS provides you with various services so that (for example) you can choose a station broadcasting your favorite categories of music, or other information. The information on the right side is available on this unit.

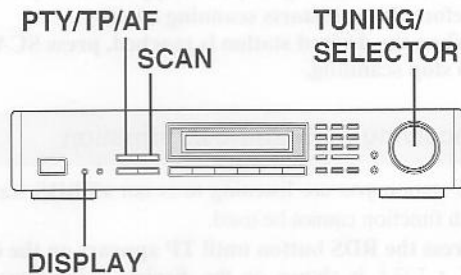

### PTY Classifications in Europe

1	NEWS	News reports	Reports on current events and happenings.
2	AFFAIRS	Current affairs	Topical reporting of current affairs, often with a wider range of topics than news reports.
3	INFO	Information	General information such as weather forecasts, consumer affairs, medical help etc.
4	SPORT	Sport	Live sports action, sports news and interviews.
5	EDUCATE	Education	Formal educational programs.
6	DRAMA	Drama	Radio plays and serials
7	CULTURE	Culture	Cultural programs (including religious affairs)
8	SCIENCE	Science and technology	Programs about the natural sciences and technology.
9	VARIED	Varied	Speech based programs not covered by the above categories eg. quizzes, panel games, comedy, etc.
10	POP M	Pop music	Popular commercial music, usually included in past or present sales charts.
11	ROCK M	Rock music	Popular music with a more specialist appeal, often not included in sales charts.
12	M.O.R M	Middle of the road music	Easy listening music as opposed to Pop, Rock or Classical.
13	LIGHT M	Light classics	Classical music for general rather than specialist appreciation.
14	CLASSICS	Serious classics	Performances of major orchestral works, symphonies, chamber music etc. and including Grand Opera.
15	OTHER M	Other music	Music styles not covered by the above categories, eg. Jazz, Rhythm & Blues, Folk, Country, Reggae.

### PS: Program Service Name

When an RDS station broadcasting PS information is received, the name of the station will be displayed instead of the frequency.

### PTY: Program Type

When an RDS station broadcasting PTY information is received, the type (category) of the broadcast will be displayed.

### TP: Traffic Program

When an RDS station broadcasting TP information is received, the traffic information will be displayed.

### AF: Alternative Frequency list

When a station broadcasting AF information is received, a frequency list of the stations servicing the same program in the surrounding is provided. From this list, the tuner can automatically search for the strongest frequency for a given station.

### RT: Radio Text

When an RDS station broadcasting RT information is received, the information received from the station will be shown on the tuner's display.

### NOTE:

In some cases, the characters displayed on the screen of the T-450RDS may not be exactly the same as the ones broadcast by the radio station. The T-450RDS cannot display lower case letters, and will change them to upper case. If strange characters appear in the display, it is because characters are being received that cannot be correctly displayed by the T-450RDS. They do not indicate a malfunction of the unit.

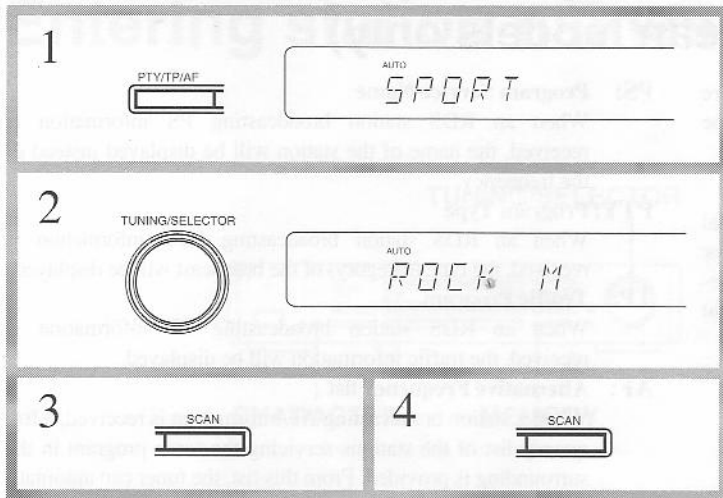

### Searching for a station which broadcasts your favorite category (PTY scan)

1. Press the RDS button, and the program type of the currently selected station will be shown on the display (for example, "SPORT").  
If the station you are receiving is not broadcasting RDS, "NOT RDS" (this is not an RDS station) will be shown on the display.
2. Use the TUNING/SELECTOR dial to select another program type (PTY) (for example, "ROCK M").  
See the PTY descriptions on the previous page.
3. Press the SCAN button to start searching for the chosen PTY. When a station is received with the desired PTY, the scanning stops for approximately 5 seconds, before the unit starts scanning again.
4. When the desired station is reached, press SCAN again to stop scanning.

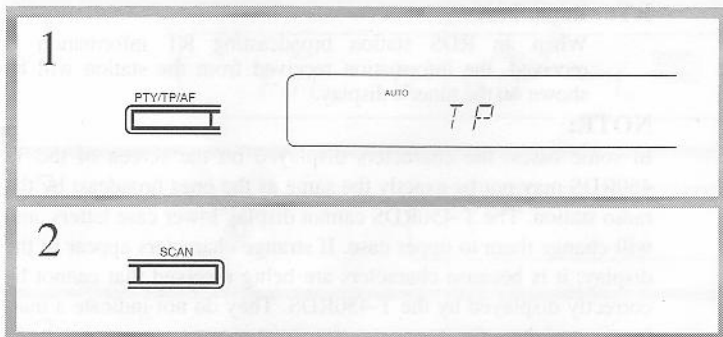

### Receiving RDS traffic information

If the station you are listening to is not an RDS station, this search function cannot be used.

1. Press the RDS button until TP appears on the display.  
If \* TP \* is shown on the display, it indicates that the current station is broadcasting traffic information.
2. Press the SCAN button to start searching for a TP station.  
When the unit receives a TP station, it stops scanning. If the unit cannot receive any signal, "NOT FIND" (cannot find the station) is shown on the display.

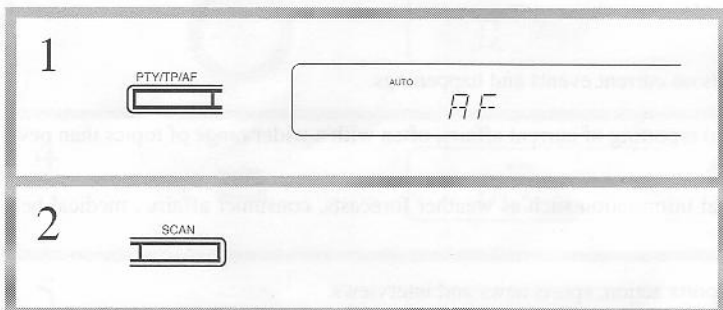

### Searching for the station which sends the clearest and strongest signal. (AF search)

If the station you are listening to is not an RDS station, this search function cannot be used.

1. Press the RDS button until AF appears on the display.  
If the station you are receiving is not broadcasting RDS, "NOT RDS" (this is not an RDS station) will be shown on the display.
2. Press the SCAN button to start searching for the strongest signal that this station can be received on.

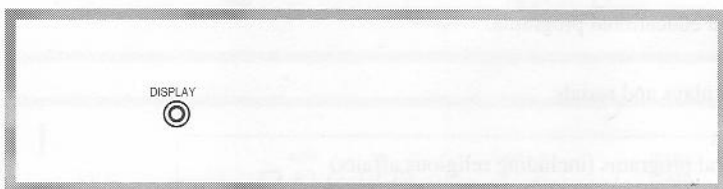

### Displaying Radio Text (RT)

If the station you are listening to is not an RDS station, this function cannot be used.

1. Each time you press the DISPLAY button, the display changes as follows.

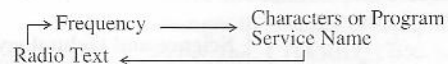

If the current station you are listening to is not an RDS station, only the frequency of the station or the station name, if you have entered it (see page 11) appears. (If there have been no characters entered, only the frequency is shown.)

When RT is received, it can sometimes take between a few seconds and 15 seconds (more or less) to show RT on the display. Sometimes the following messages will be shown on the display. **WAIT:** indicates that it requires more time to receive the RT information. When the information is received, the characters will scroll across the display.

**NO TEXT:** this appears for 3 seconds and indicates that even though an RDS station is being received, there is no RT information included.

# Receiving RDS (U.S.A. models only)

RDS reception is only available in areas where RDS broadcasts are available. However, if radio reception is weak, RDS may not be received.

## What is RDS?

Many FM stations now transmit RDS signals which give additional information. RDS provides you with various services so that (for example) you can choose a station broadcasting your favorite categories of music, or other information. The information on the right side is available on this unit.

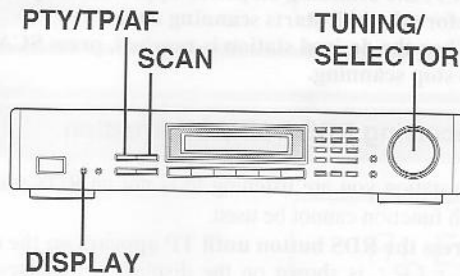

## PS: Program Service Name

When an RDS station broadcasting PS information is received, the name of the station will be displayed instead of the frequency.

## PTY: Program Type

When an RDS station broadcasting PTY information is received, the type (category) of the broadcast will be displayed.

## TP: Traffic Program

When an RDS station broadcasting TP information is received, the traffic information will be displayed.

## AF: Alternative Frequency list

When a station broadcasting AF information is received, a frequency list of the stations servicing the same program in the surrounding is provided. From this list, the tuner can automatically search for the strongest frequency for a given station.

## RT: Radio Text

When an RDS station broadcasting RT information is received, the information received from the station will be shown on the tuner's display.

## CT: Clock Time

When an RDS station broadcasting CT information is received, a clock will appear on the display within 1 minute from the time the station is received.

## ALERT:

When an RDS station is making an emergency broadcast, ALERT will appear on the display, and flash on and off.

## NOTE:

In some cases, the characters displayed on the screen of the T-450RDS may not be exactly the same as the ones broadcast by the radio station. The T-450RDS cannot display lower case letters, and will change them to upper case. If strange characters appear in the display, it is because character are being received that cannot be correctly displayed by the T-450RDS. They do not indicate a malfunction of the unit.

## PTY Classifications in U.S.A.

0	No Program Type Code	13	NOSTALGA	Nostalgia	
1	NEWS	News	14	JAZZ	Jazz
2	INFORM	Information	15	CLASSICL	Classical
3	SPORTS	Sports	16	R & B	R & B
4	TALK	Talk	17	SOFT R & B	Soft R & B
5	ROCK	Rock	18	LANGUAGE	Language
6	CLS ROCK	Classic Rock	19	REL MUSC	Religious Music
7	ADLT HIT	Adult Hits	20	REL TALK	Religious Talk
8	SOFT RCK	Soft Rock	21	PERSNLTY	Personality
9	TOP 40	Top 40	22	PUBLIC	Public
10	COUNTRY	Country	23~29		Spares
11	OLDIES	Oldies	30	TEST	Emergency Test
12	SOFT	Soft			

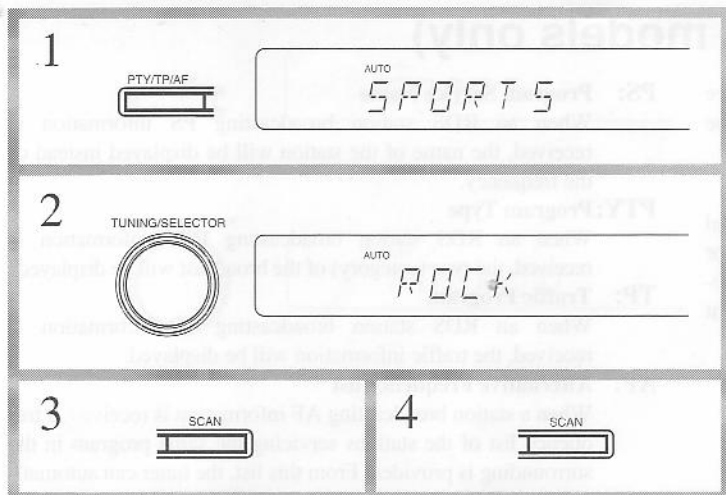

### Searching for a station which broadcasts your favorite category (PTY scan)

1. Press the **RDS** button, and the program type of the currently selected station will be shown on the display (for example, "SPORT").  
If the station you are receiving is not broadcasting RDS, "NOT RDS" (this is not an RDS station) will be shown on the display.
2. Use the **TUNING/SELECTOR** dial to select another program type (PTY) (for example, "ROCK").  
See the PTY descriptions on the previous page.
3. Press the **SCAN** button to start searching for the chosen PTY. When a station is received with the desired PTY, the scanning stops for approximately 5 seconds, before the unit starts scanning again.
4. When the desired station is reached, press **SCAN** again to stop scanning.

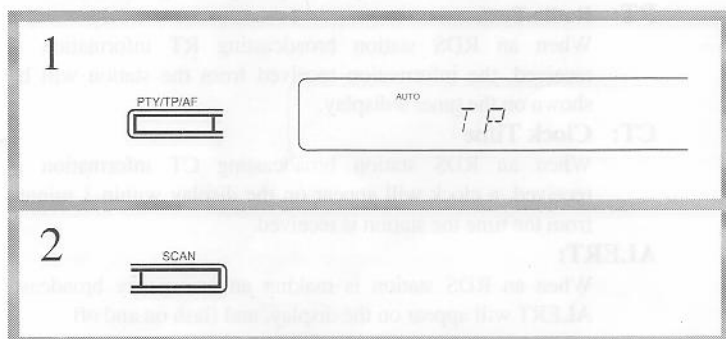

### Receiving RDS traffic information

If the station you are listening to is not an RDS station, this search function cannot be used.

1. Press the **RDS** button until **TP** appears on the display.  
If \*TP\* is shown on the display, it indicates that the current station is broadcasting traffic information.
2. Press the **SCAN** button to start searching for a TP station.  
When the unit receives a TP station, it stops scanning. If the unit cannot receive any signal, "NOT FIND" (cannot find the station) is shown on the display.

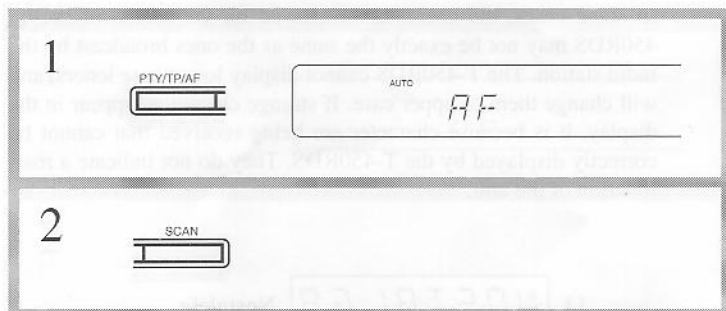

### Searching for the station which sends the clearest and strongest signal. (AF search)

If the station you are listening to is not an RDS station, this search function cannot be used.

1. Press the **RDS** button until **AF** appears on the display.  
If the station you are receiving is not broadcasting RDS, "NOT RDS" (this is not an RDS station) will be shown on the display.
2. Press the **SCAN** button to start searching for the strongest signal that this station can be received on.



### Displaying Radio Text (RT)

If the station you are listening to is not an RDS station, this function cannot be used.

1. Each time you press the **DISPLAY** button, the display changes as follows.

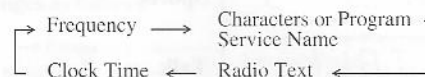

If the current station you are listening to is not an RDS station, only the frequency of the station or the station name, if you have entered it (see page 11) appears. (If there have been no characters entered, only the frequency is shown.)

When RT is received, it can sometimes take between a few seconds and 15 seconds (more or less) to show RT on the display. Sometimes the following messages will be shown on the display. **WAIT:** indicates that it requires more time to receive the RT information. When the information is received, the characters will scroll across the display.

**NO TEXT:** this appears for 3 seconds and indicates that even though an RDS station is being received, there is no RT information included.

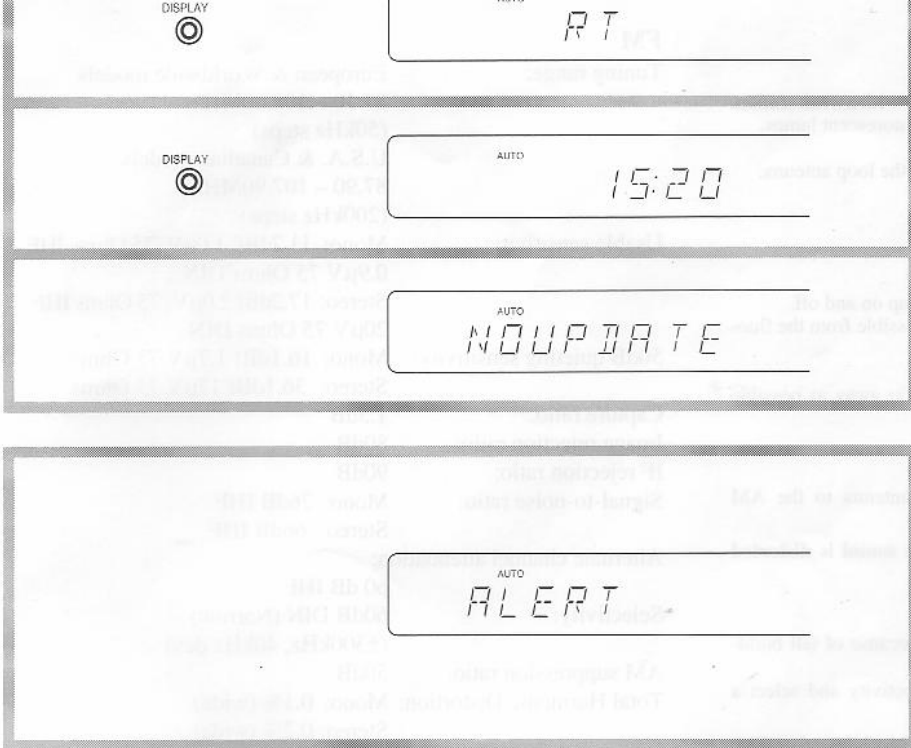

If the station you are listening to is not an RDS station, this function cannot be used.

1. Press the DISPLAY button and RT will be displayed.
  2. Press the DISPLAY button one more time.
- If a station broadcasting CT information is being received, a clock will appear on the display within 1 minute. If a station broadcasting CT information is not being received, within several seconds NO UPDATE or NO TIME will appear on the display, then the PS display will return.

### When an RDS station is making an emergency broadcast

If the station you are listening to is not an RDS station, this function cannot be used. When the station being received is making an emergency broadcast, ALERT will flash on and off, on the display. While this is flashing, the DISPLAY button cannot be used.



# Trouble shooting guide

- **No power.**  
*Cause:* Power cord is disconnected.  
*Remedy:* Connect power cord.
- **Buzzing noise on AM, usually conspicuous at night or with a weak station.**  
*Cause:* Noise from electrical apparatus such as fluorescent lamps.  
*Remedy:* Move set to different location.  
*Remedy:* Change the position or direction of the loop antenna.
- **High pitched noise.**  
*Cause:* Noise from TV.  
*Remedy:* Keep unit away from TV set.
- **Crackling noise on AM and FM.**  
*Cause:* Noise caused by turning a fluorescent lamp on and off.  
*Remedy:* Move the antenna as far away as possible from the fluorescent lamp.  
*Cause:* Noise from automobile ignition.  
*Remedy:* Install an outdoor FM antenna as far away as possible from the road.
- **AM stations cannot be received.**  
*Cause:* AM loop antenna is not attached.  
*Remedy:* Connect the included AM loop antenna to the AM antenna terminals.
- **TUNED indicators and stereo indicator light but sound is distorted and separation is bad.**  
*Cause:* Station is too strong.  
*Remedy:* Change to T-shaped antenna.  
*Cause:* Multiple reflection of the radio waves because of tall buildings or mountains.  
*Remedy:* Use antenna which has better directivity and select a point with the least distortion.
- **TUNED indicators and stereo indicator flicker and hiss is heard on FM.**  
*Cause:* Station is too weak.  
*Remedy:* Install an outdoor FM antenna.  
*Remedy:* Change the position or direction of the outdoor antenna.  
*Cause:* Stereo FM broadcasts cover only about half the distance of an ordinary broadcast.  
*Remedy:* Switch to mono reception. (Even stereo broadcasts will be heard in mono.)
- **No station, or an undesired station is recalled when a Preset button is pressed.**  
*Cause:* The power cord has been unplugged for a long time.  
*Remedy:* The memory contents are lost if the power is not turned on and off a few times each month. Store all stations in the memory again and remember to turn power on and off a few times each month.
- **The RDS function does not work.**  
*Cause:* The station is not an RDS station.  
*Remedy:* Receive an RDS station.  
*Cause:* The reception station signal is too weak.  
*Remedy:* Install an outdoor FM antenna.  
*Remedy:* Change the position or direction of the outdoor antenna.  
*Cause:* Too much interference.  
*Remedy:* Move the antenna as far away as possible from fluorescent lamps.  
*Remedy:* Install an outdoor FM antenna.
- The tuning steps by which the tuned frequency increases/decreases have been set at the factory to the proper value for the area where each unit is to be sold. If you use the unit in a country where a different tuning step is required or if the broadcast frequencies in your country change so that you can not tune in radio stations precisely, change the tuning step frequency switch if your model is the Worldwide model (see page 4), or contact your ONKYO authorized service center.
- Excessive electrical interference may temporarily render this system's sensitive microcomputer inoperable. If this happens, unplug the system for at least five seconds.

# Specifications

## FM

Tuning range:	European & Worldwide models 87.50 – 108.00MHz (50kHz steps) U.S.A. & Canadian models 87.90 – 107.90MHz (200kHz steps)
Usable sensitivity:	Mono: 11.2dBf, 1.0µV, 75 Ohms IHF 0.9µV 75 Ohms DIN Stereo: 17.2dBf 2.0µV, 75 Ohms IHF 20µV 75 Ohms DIN
50dB quieting sensitivity:	Mono: 16.1dBf 1.7µV 75 Ohms Stereo: 36.1dBf 17µV 75 Ohms
Capture ratio:	1.5dB
Image rejection ratio:	80dB
IF rejection ratio:	90dB
Signal-to-noise ratio:	Mono: 76dB IHF Stereo: 66dB IHF
Alternate channel attenuation:	60 dB IHF
Selectivity:	60dB DIN (Narrow) (±300kHz, 40kHz dev)
AM suppression ratio:	50dB
Total Harmonic Distortion:	Mono: 0.1% (wide) Stereo: 0.2% (wide)
Frequency response:	30 – 15,000Hz (±1.5 dB)
Stereo separation:	40dB at 1kHz (wide) 30dB at 70 – 10,000Hz (wide)
Output voltage:	0.75V, 0.5V (U.S.A. models only)
Muting level:	17.2 dBf 2.0 µV, 75 Ohms

## AM

Tuning range:	U.S.A. & Canadian models: 530–1710 kHz (10 kHz steps) European models: 522–1611 kHz (9 kHz steps) Worldwide models: 531–1602 kHz (9 kHz steps) 530–1710 kHz (10 kHz steps)
Usable sensitivity:	25µV
Image rejection ratio:	40dB
IF rejection ratio:	40dB
Signal-to-noise ratio:	40dB
Total Harmonic Distortion:	0.7%
Output voltage:	150mV

## General

Power supply:	European models (except U.K.): AC 230V, 50Hz U.S.A. & Canadian models: AC 120V, 60Hz U.K. & Australian models: AC 240V, 50Hz Worldwide models: AC 120V and 220V switchable, 50/60Hz
Dimensions (W × H × D):	455 × 90 × 306 mm 17-15/16" × 3-9/16" × 12-1/16"
Weight:	3.6 kg, 7.4 lbs.

Specifications and features are subject to change without notice.

# Trouble shooting guide Specifications MEMO

- No power:
  - Check power cord connection.
  - Remedy: Connect power cord.
- Reception of AM signals is poor or difficult to receive a weak station.
  - Check: Make sure reception antenna is set in the correct range.
  - Remedy: Move set to different location.
  - Remedy: Change the position or direction of the loop antenna.
- High pitched noise:
  - Check: Turn on FM.
  - Remedy: Turn off FM.
- Clicking noise on AM and FM:
  - Check: Turn on the volume control & the automatic loop extend off.
  - Remedy: Move the antenna as far away as possible from the power lines.
  - Check: Move from magnetic fields.
  - Remedy: Move an antenna FM antenna away from the power lines.
- AM signals cannot be received:
  - Check: AM loop antenna is not stretched.
  - Remedy: Stretch the stretched AM loop antenna to the AM signal strength.
- TUNED indicator and status indicator light not lit when a selected station is on:
  - Check: Turn off the antenna.
  - Remedy: Change to TUNED mode.
  - Check: Multiple reflections of the radio waves between the antenna and the receiver.
  - Remedy: Use a receiver which has better selectivity and reject a part with the loop antenna.
- TUNED indicator and status indicator light not lit when a selected station is on:
  - Check: Station is too weak.
  - Remedy: Switch an antenna FM antenna.
  - Remedy: Change the position or direction of the stretched antenna.
  - Check: Turn off FM broadcasting even with short antenna, use of an ordinary antenna.
  - Remedy: Switch to better reception FM antenna or antenna with short antenna.
- No station or an unexpected station is received when a strong station is present:
  - Check: The power cord is not plugged in a long time.
  - Remedy: The antenna extends the length of the antenna to the station and cut off a few times each month. Turn off antenna.
  - Remedy: Again stretch the antenna to turn power the end of a few times each month.
- The AM function does not work:
  - Check: The volume control is AM status.
  - Remedy: Turn on AM/FM system.
  - Check: The reception status signal is too weak.
  - Remedy: Turn on receiver FM antenna.
  - Remedy: Change the position or direction of the antenna antenna.
  - Check: The weak performance.
  - Remedy: Move the antenna as far away as possible from the power lines.
  - Remedy: Stretch an antenna FM antenna.
- The radio frequency which the radio receiver's receiver circuit has been tuned to is different to the correct value for the station which is broadcast to the radio receiver:
  - Check: The frequency of the station which is broadcast to the radio receiver is different to the broadcast frequency in your country. Change the dial with the correct one. In radio station program, change the dial with the correct value of your country. For the details, consult page 31 of product user's manual or the manufacturer's website.
  - Check: Receiver performance. For the details, consult the operator's manual. Alternatively, for the details, consult the website of the manufacturer.

## FM

Tuning range	87.5 - 107.9 MHz
IF spacing	10.7 MHz
IF rejection ratio	> 40 dB
Signal-to-noise ratio	> 40 dB
Total Harmonic Distortion	< 0.5%
Carrier voltage	100 mV
IF adjustment ratio	> 40 dB
IF adjustment ratio	> 40 dB
Signal-to-noise ratio	> 40 dB
Carrier voltage	100 mV

General	
Power supply	AC 230V 50Hz
Dimensions	180 x 140 x 110 mm
Weight	1.2 kg
Frequency response	20 Hz - 20 kHz
Dynamic range	100 dB
THD	< 0.5%
SNR	> 40 dB
Power output	100 mW
Modulation	FM

## AM

Tuning range	530 - 1700 kHz
IF spacing	455 kHz
IF rejection ratio	> 40 dB
Signal-to-noise ratio	> 40 dB
Total Harmonic Distortion	< 0.5%
Carrier voltage	100 mV
General	
Power supply	AC 230V 50Hz
Dimensions	180 x 140 x 110 mm
Weight	1.2 kg
Frequency response	20 Hz - 20 kHz
Dynamic range	100 dB
THD	< 0.5%
SNR	> 40 dB
Power output	100 mW
Modulation	AM

## ONKYO CORPORATION

Sales Planning & Promotion Dept.: 2-1, Nisshin-cho, Neyagawa-shi, OSAKA 572, JAPAN  
 Tel: 0720-31-8133 Fax: 0720-34-1340

**ONKYO U.S.A CORPORATION**  
 200 Williams Drive, Ramsey, N.J. 07446, U.S.A.  
 Tel: 201-825-7950 Fax: 201-825-8150

**ONKYO DEUTSCHLAND GMBH ELECTRONICS**  
 Industriestrasse 18-20, 8034 Germering, GERMANY  
 Tel: 089 84 93 20 Fax: 089 84 93 226 TLX: 05-21726 ONKY D

**ONKYO FRANCE**